

BF8BE9701BB

Label	Basic Editions	Ongoing 2011	Date Folder Modified	16 FEB 2011 11:59 AM	
Size Range	B- 4-16	DENIM 5 PKT			
Boy	Ship Date	03 MAR 2008	SHGS Sourcing	Catherine Loong	
Designer Galina Goldshteyn	Technical Design	Buyer	Sourcing	Howard Mohney	
Pre-Production		Carryover	Reference/LY #	BBEF062004	

Fabric Description	rope dye denim	SHGS TD		Manufacturing Country	Bangladesh
Fabric Content	100% ctn	Date Sample Received	24 JAN 2008	Vendor	Starlight
Fabric Construction	72x46/ 7x6	Packaging Method	Hanging	Mill/Art#	
Fabric Weight		PDM Process		Floor Set Date	7/1
Fabric Width		Fabric Finish/Wash		Merchant Requested	Yes
Fabric Code	DH0628	Additonal Information		Adopted Style (YES/NO)	

<b>Color</b>
SEE PEG SHEET

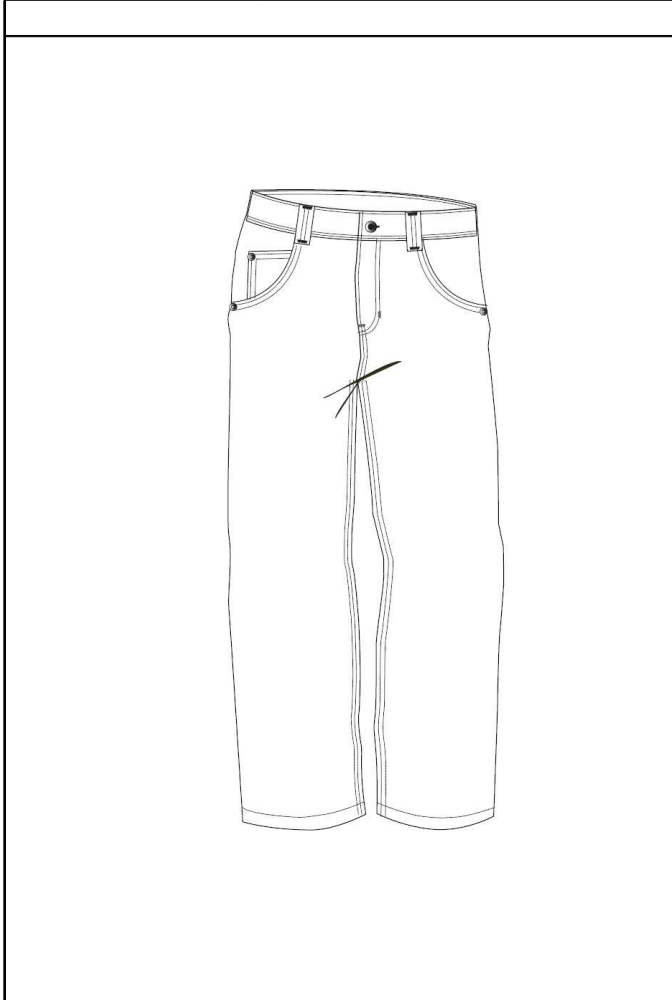

APPROVED. FINAL SPECIFICATION-FOR PRODUCTION MANUFACTURING.

GARMENT MUST PASS THE APPROVAL OF THE BUYER AND PRODUCT DEVELOPMENT FOR APPEARANCE, FABRICATION, TRIM, AND ANY ARTWORK. IN ADDITION, GARMENT MUST PASS ALL LAB TESTING.

BF8BE9701BB

Label	Basic Editions	Ongoing 2011	Date Folder Modified	16 FEB 2011 11:59 AM
Size Range	B- 4-16	DENIM 5 PKT		
Boy	Ship Date	03 MAR 2008	SHGS Sourcing	Catherine Loong
Designer Galina Goldshteyn	Technical Design	Buyer	Sourcing	Howard Mohney
Pre-Production		Carryover	Reference/LY #	BBEF062004

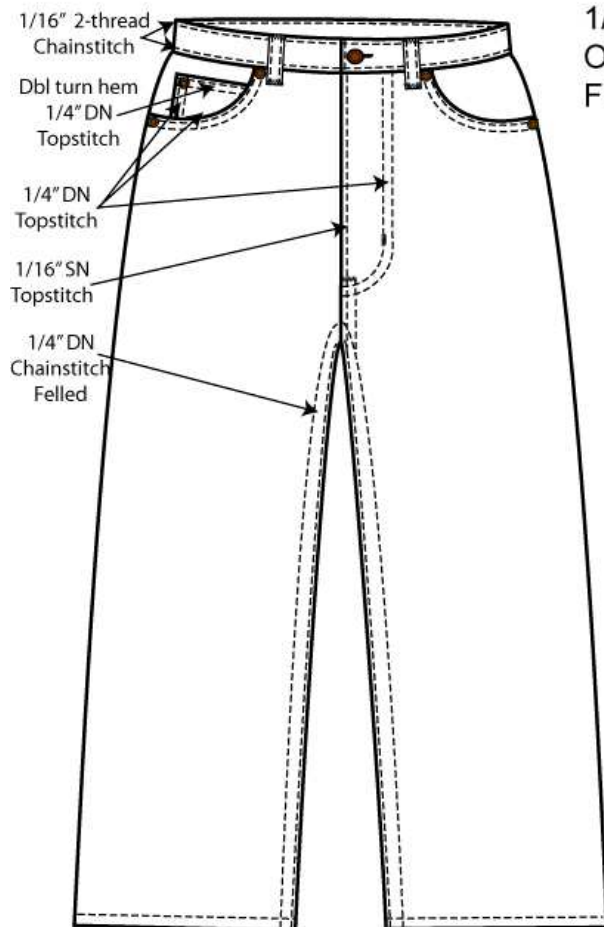
**Image Name: 9701 Basic Jean****Cutting: Lengthwise Grain****Joined Seams:****Back Rise, Yoke, Inseam: Felled with****1/4" DN 2-thread Chainstitch****Outseam: 5 Thread Safety Overlock****Front Rise: Mock Fell, 1/4" DN Topstitch**

Waistband: Interline. See detail for inside elastic.  
 Sizes 4-7 Elastic Back Waist, Snap Closure  
 Sizes 8-18: Rigid Back Waist, Button CF Waist,  
 Adjustable Elastic at Inside WB

Belt Loops: 1/4" DN Coverstitch centered on loops.  
 Horizontal Bartack at top and bottom edges.

Fly: Interline. DN J stitch and 1/16" Topstitch Flye Edge.  
 2-Ply Fly Facing (folded)  
 2 Bartacks as sketch.

Cording Stitch: SN Lockstitch at back side of outseam  
 Bartack ends to secure.

Front Scoop Pocket:  
 Clean finish opening to pocket bag.  
 Facing is overlock finished and SN joined to lining bag  
 Pocket bag is clean finished with french seam  
 Set Rivets Securely.

Coin Pocket: Double turn opening and DN Topstitch  
 Attach to body with DN Topstitch  
 Set Rivet Securely

Back Pocket:  
 Double Turn Hem and DN Topstitch  
 Attach to body with DN Topstitch

Hem: Double turn. SN Topstitch. Set hem circular.

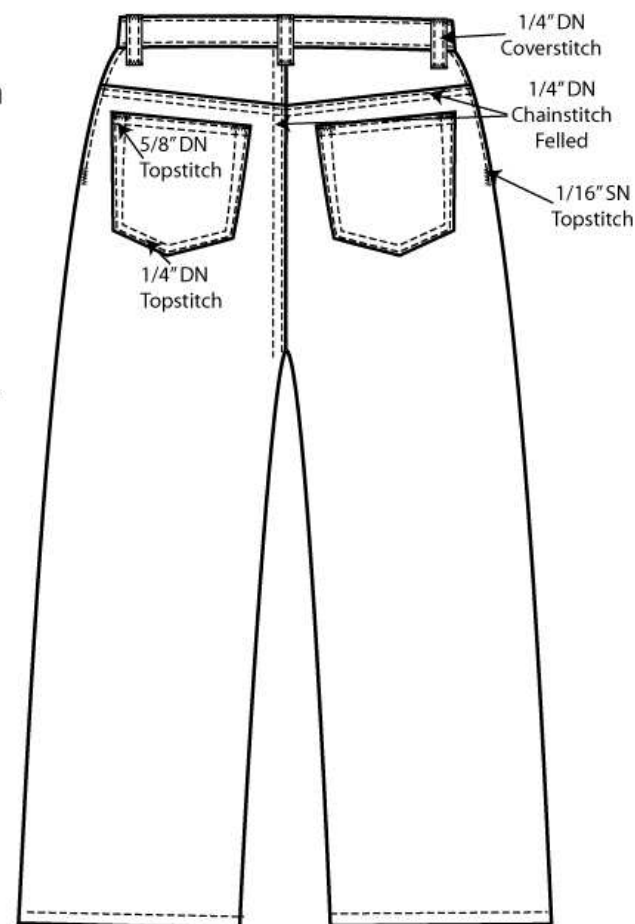

FOLLOW SEARS HOLDINGS MINIMUM CONSTRUCTION STANDARDS.

BF8BE9701BB

Label	Basic Editions	Ongoing 2011	Date Folder Modified	16 FEB 2011 11:59 AM
Size Range	B- 4-16	DENIM 5 PKT		
Boy	Ship Date	03 MAR 2008	SHGS Sourcing	Catherine Loong
Designer Galina Goldshteyn	Technical Design	Buyer	Sourcing	Howard Mohny
Pre-Production		Carryover	Reference/LY #	BBEF062004



Image Name: 9701 Elastic Back

Size 8 - 16

INSIDE ADJUSTABLE ELASTIC WAIST CONSTRUCTION STANDARD

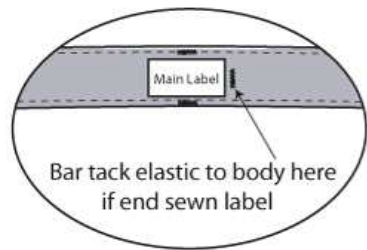
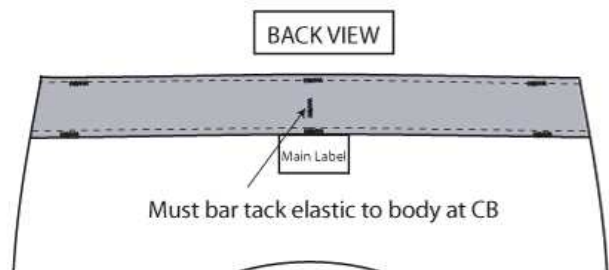
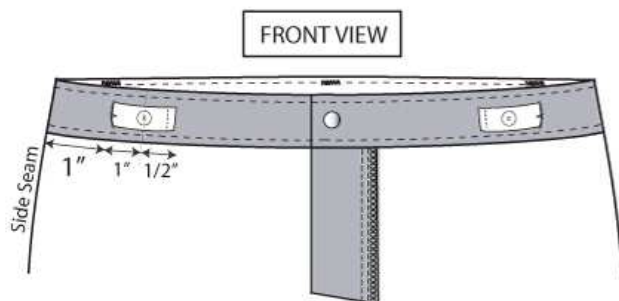

Size 4-7

Rigid Front with Full Elastic Back  
 1/16" Edgestitch with 2 rows SN chainstitch  
 spaced equally between top & bottom  
 Snap closure at CF

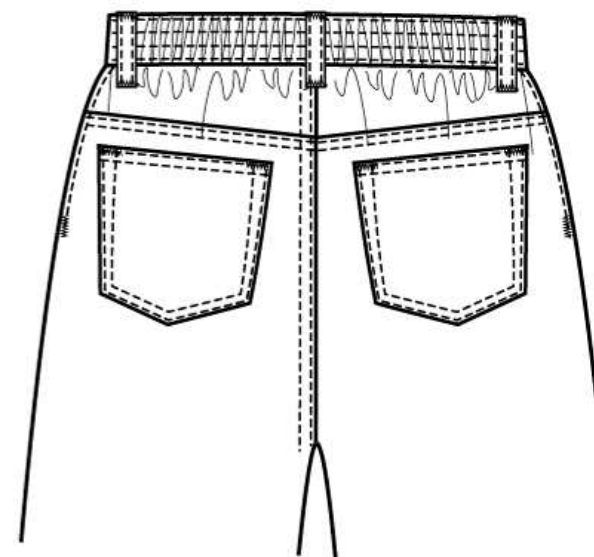

FOLLOW SEARS HOLDINGS MINIMUM CONSTRUCTION STANDARDS.

BF8BE9701BB

Label	Basic Editions	Ongoing 2011	Date Folder Modified	16 FEB 2011 11:59 AM	
Size Range	B- 4-16	DENIM 5 PKT			
Boy	Ship Date	03 MAR 2008	SHGS Sourcing	Catherine Loong	
Designer Galina Goldshteyn	Technical Design	Buyer	Sourcing	Howard Mohney	
Pre-Production		Carryover	Reference/LY #	BBEF062004	

Company: Sears Holding Corporation	Sample Size: 5	Approval Note:	UOM: Imperial (in)
Product Type: Woven Bottom	Size Class: Boy		Shown As: Graded
	Approval Status: Neither approved nor rejected		

Size Range: K-4 -20

P O M	Description	Tol (-)	Tol (+)	4	[5]	6	7						
WB20	Waistband Height	-1/8	1/8	1 1/2	1 1/2	1 1/2	1 1/2						
WA60	Waist Relaxed -Straight Band Front/Elastic Back	-1/2	1/2	22	22 1/2	23	23 1/2						
WA51	Waist- Extended	-0	0	24 1/2	25	25 1/2	26						
ST67	Seat Placement up from Crotch	-0	0	2 1/2	2 1/2	2 1/2	2 1/2						
ST65	Seat Up from Crotch	-1/2	1/2	27	28	29	30						
TH51	Thigh- 1" below Crotch	-1/4	1/4	16 3/4	17 3/8	18	18 5/8						
KN58	Knee- Placement down from Crotch	-1/8	1/8	8 1/4	9	9 1/4	9 5/8						
KN59	Knee Down from Crotch (Bootcut/Flared)	-3/8	3/8	15 1/8	15 1/2	15 7/8	16 1/4						
LO60	Leg Opening- Straight--Ankle	-1/4	1/4	13 5/8	14	14 3/8	14 3/4						
FR52	Front Rise from Top of Garment Edge (curved)	-1/4	1/4	7 5/8	8 1/4	8 7/8	9 1/4						
BR51	Back Rise from Top of Garment Edge(curved)	-1/4	1/4	10 7/8	11 1/2	12 1/8	12 1/2						
IN51	Inseam--Ankle	-1/2	1/2	17 7/8	19 5/8	20 3/8	21 3/8						
YH06	Yoke Height at Center Back-frm WB seam	-1/8	1/8	3 1/4	3 1/4	3 1/4	3 1/4						
YH08	Yoke Height at Side Seam- fm WB seam	-1/8	1/8	2 1/4	2 1/4	2 1/4	2 1/4						
FR66	"J" Stitch Length	-1/8	1/8	4	4 1/4	4 1/2	4 3/4						
FR67	"J" Stitch Width	-0	0	1 1/4	1 1/4	1 1/4	1 1/4						
BL00	Belt Loop Width	-0	0	1/2	1/2	1/2	1/2						
BL01	Belt Loop Length	-1/8	1/8	2 1/4	2 1/4	2 1/4	2 1/4						
HH01	Hem Height--Leg Opening	-1/8	1/8	5/8	5/8	5/8	5/8						
	FRONT POCKETS												
PP87	Pocket Placement- Horizontal from Side Seam	-1/8	1/8	3	3	3	3						
PP86	Pocket Placement- Vertical from Waist	-1/8	1/8	2 1/4	2 1/4	2 1/4	2 1/4						
PB85	Pocket Bag Length	-1/4	1/4	8 1/2	8 1/2	8 1/2	8 1/2						
PB86	Pocket Bag Width	-1/4	1/4	5 1/2	5 1/2	5 1/2	5 1/2						
	COIN POCKET												
CP51	Coin Pocket Width	-1/8	1/8	2 1/4	2 1/4	2 1/4	2 1/4						
CP54	Coin Pocket Placement- Waistband Seam	-1/8	1/8	1	1	1	1						
CP56	Coin Pocket Placement- Side Seam	-1/8	1/8	3/4	3/4	3/4	3/4						
	BACK POCKETS												
PP88	Pocket Placement- Distance from Yoke at Side Seam	-1/8	1/8	1	1	1	1						

BF8BE9701BB

Label	Basic Editions	Ongoing 2011	Date Folder Modified	16 FEB 2011 11:59 AM
Size Range	B- 4-16	DENIM 5 PKT		
Boy	Ship Date	03 MAR 2008	SHGS Sourcing	Catherine Loong
Designer Galina Goldshteyn	Technical Design	Buyer	Sourcing	Howard Mohny
Pre-Production	Carryover		Reference/LY #	BBEF062004



Size Range: K-4 -20

P O M	Description	Tol (-)	Tol (+)	4	[5]	6	7						
PP89	Pocket Plcmnt- Distance from Yoke near Center Back	-1/8	1/8	3/4	3/4	3/4	3/4						
PH90	Pocket Height at Center	-1/8	1/8	4 1/2	4 1/2	4 1/2	4 1/2						
PH91	Pocket Height at Side	-1/8	1/8	4	4	4	4						
PW92	Pocket Width at Top Edge--General	-1/8	1/8	4 1/2	4 1/2	4 1/2	4 1/2						
PW93	Pocket Width at Bottom	-1/8	1/8	3 1/2	3 1/2	3 1/2	3 1/2						

BF8BE9701BB

Label	Basic Editions	Ongoing 2011	Date Folder Modified	16 FEB 2011 11:59 AM	
Size Range	B- 4-16	DENIM 5 PKT			
Boy	Ship Date	03 MAR 2008	SHGS Sourcing	Catherine Loong	
Designer Galina Goldshteyn	Technical Design	Buyer	Sourcing	Howard Mohney	
Pre-Production		Carryover	Reference/LY #	BBEF062004	

Company: Sears Holding Corporation	Sample Size: 12	Approval Note:	UOM: Imperial (in)
Product Type: Woven Bottom	Size Class: Boy		Shown As: Graded
	Approval Status: Neither approved nor rejected		

Size Range: K-4 -20

POM	Description	Tol (-)	Tol (+)	8	10	[12]	14	16	18				
WB20	Band Height- Waist- Bottom	-1/8	1/8	1 1/2	1 1/2	1 1/2	1 1/2	1 1/2	1 1/2				
WA60	Waist Straight Band	-1/2	1/2	25	26 1/4	27 1/2	28 1/2	29 1/2	30 1/2				
00	Inside Buttonhole Placement from SS on WB	-1/4	0	1	1	1	1	1					
00	Inside Button Placement from Buttonhole	-1/4	1/4	1	1	1	1	1					
ST67	Seat Placement up from Crotch	-0	0	3	3	3	3	3	3				
ST65	Seat Up from Crotch	-1/2	1/2	31 1/2	33	35	37	39	40 1/2				
TH51	Thigh- 1" below Crotch	-1/4	1/4	19 3/4	20 3/4	22	23 1/4	24 1/2	25 1/2				
KN58	Knee- Placement down from Crotch	-1/8	1/8	10 1/4	11 3/8	12 1/2	13 1/4	14	14 1/4				
KN59	Knee Down from Crotch (Bootcut/Flared)	-3/8	3/8	17 1/4	17 3/4	18 1/2	19 1/4	20	20 1/2				
LO60	Leg Opening- Straight--Ankle	-1/4	1/4	15 1/2	16	16 1/2	17	17 1/2	18				
FR52	Front Rise from Top of Garment Edge (curved)	-1/4	1/4	8 3/4	9 1/2	10 1/4	11	11 3/4	12 1/4				
BR51	Back Rise from Top of Garment Edge(curved)	-1/4	1/4	12 1/4	13	13 3/4	14 1/2	15 1/4	15 3/4				
IN51	Inseam--Ankle	-1/2	1/2	22 1/4	24 5/8	27	28 3/8	29 3/4	30 3/8				
YH06	Yoke Height at Center Back-fr top of Garment Edge	-1/8	1/8	3 3/4	3 3/4	3 3/4	3 3/4	3 3/4	3 3/4				
YH07	Yoke Height at Side Seam- fm top of Garment Edge	-1/8	1/8	2 3/4	2 3/4	2 3/4	2 3/4	2 3/4	2 3/4				
FR66	"J" Stitch Length	-1/8	1/8	5	5 1/4	5 1/2	5 3/4	6	6 1/2				
FR67	"J" Stitch Width	-0	0	1 1/4	1 1/4	1 1/4	1 1/4	1 1/4	1 1/4				
BL00	Belt Loop Width	-0	0	1/2	1/2	1/2	1/2	1/2	1/2				
BL01	Belt Loop Length	-1/8	1/8	2 1/4	2 1/4	2 1/4	2 1/4	2 1/4	2 1/4				
HH01	Hem Height--Leg Opening	-1/8	1/8	5/8	5/8	5/8	5/8	5/8	5/8				
	FRONT POCKETS												
PP87	Pocket Placement- Horizontal from Side Seam	-1/8	1/8	3 1/2	3 1/2	3 1/2	3 1/2	3 1/2	3 1/2				
PP86	Pocket Placement- Vertical from Waist	-1/8	1/8	2 3/4	2 3/4	2 3/4	2 3/4	2 3/4	2 3/4				
PB85	Pocket Bag Length	-1/4	1/4	10	10	10	10	10	10				
PB86	Pocket Bag Width	-1/4	1/4	6	6	6	6	6	6				
	COIN POCKET												
CP51	Coin Pocket Width	-1/8	1/8	2 1/2	2 3/4	2 3/4	2 3/4	2 3/4	2 3/4				
CP54	Coin Pocket Placement- Waistband Seam	-1/8	1/8	1	1	1	1	1	1				
CP56	Coin Pocket Placement- Side Seam	-1/8	1/8	3/4	3/4	3/4	3/4	3/4	3/4				
	BACK POCKETS												

BF8BE9701BB

Label	Basic Editions	Ongoing 2011	Date Folder Modified	16 FEB 2011 11:59 AM	
Size Range	B- 4-16	DENIM 5 PKT			
Boy	Ship Date	03 MAR 2008	SHGS Sourcing	Catherine Loong	
Designer Galina Goldshteyn	Technical Design	Buyer	Sourcing	Howard Mohny	
Pre-Production		Carryover	Reference/LY #	BBEF062004	



Size Range: K-4 -20

P O M	Description	Tol (-)	Tol (+)	8	10	[12]	14	16	18				
PP88	Back Pocket Placement- Distance from Yoke at Side Seam	-1/8	1/8	1 1/2	1 1/2	1 1/2	1 1/2	1 1/2	1 1/2				
PP89	Back Pocket Plcmt- Distance from Yoke near Center Back	-1/8	1/8	1	1	1	1	1	1				
PH90	Back Pocket Height at Center	-1/8	1/8	5 1/4	5 1/2	5 1/2	5 1/2	5 1/2	5 1/2				
PH91	Back Pocket Height at Side	-1/8	1/8	4 3/4	5	5	5	5	5				
PW92	Pocket Width at Top Edge--General	-1/8	1/8	5 1/4	5 1/2	5 1/2	5 1/2	5 1/2	5 1/2				
PW93	Back Pocket Width at Bottom	-1/8	1/8	4 1/4	4 1/2	4 1/2	4 1/2	4 1/2	4 1/2				



BF8BE9701BB

Label	Basic Editions	Ongoing 2011	Date Folder Modified	16 FEB 2011 11:59 AM	
Size Range	B- 4-16	DENIM 5 PKT			
Boy	Ship Date	03 MAR 2008	SHGS Sourcing	Catherine Loong	
Designer Galina Goldshteyn	Technical Design	Buyer	Sourcing	Howard Mohney	
Pre-Production		Carryover	Reference/LY #	BBEF062004	

Company: Sears Holding Corporation	Sample Size: 12H	Approval Note:	UOM: Imperial (in)
Product Type: Jean	Size Class: Husky Boy		Shown As: Graded
	Approval Status: Neither approved nor rejected		

Size Range: 8H-18H

POM	Description	Tol (-)	Tol (+)	8H	10H	[12H]	14H	16H					
WB20	Band Height- Waist- Bottom	-1/8	1/8	1 1/2	1 1/2	1 1/2	1 1/2	1 1/2					
WA60	Waist Straight Band	-1/2	1/2	27	28 1/4	29 1/2	30 1/2	31 1/2					
00	Inside Buttonhole Placement from SS on WB	-1/4	1/4	1	1	1	1	1					
00	Inside Button Placement from Buttonhole	-1/4	1/4	1	1	1	1	1					
ST67	Seat Placement up from Crotch	-0	0	3	3	3	3	3					
ST65	Seat Up from Crotch	-1/2	1/2	34	35 1/2	37 1/2	39 1/2	41 1/2					
TH51	Thigh- 1" below Crotch	-1/4	1/4	21 1/2	22 1/2	23 3/4	25	26 1/4					
KN58	Knee- Placement down from Crotch	-1/8	1/8	10 1/4	11 3/8	12 1/2	13 1/4	14					
KN59	Knee Down from Crotch (Bootcut/Flared)	-3/8	3/8	18 1/4	18 3/4	19 1/2	20 1/4	21					
LO60	Leg Opening- Straight--Ankle	-1/4	1/4	16	16 1/2	17	17 1/2	18					
FR52	Front Rise from Top of Garment Edge (curved)	-1/4	1/4	9 1/4	10	10 3/4	11 1/2	12 1/4					
BR51	Back Rise from Top of Garment Edge(curved)	-1/4	1/4	13	13 3/4	14 1/2	15 1/4	16					
IN51	Inseam--Ankle	-1/2	1/2	22 1/4	24 5/8	27	28 3/8	29 3/4					
YH06	Yoke Height at Center Back- frm WB seam	-1/8	1/8	3 3/4	3 3/4	3 3/4	3 3/4	3 3/4					
YH07	Yoke Height at SS- fm WB seam	-1/8	1/8	2 3/4	2 3/4	2 3/4	2 3/4	2 3/4					
FR66	"J" Stitch Length	-1/8	1/8	5	5 1/2	5 1/2	6	6					
FR67	"J" Stitch Width	-0	0	1 1/4	1 1/4	1 1/4	1 1/4	1 1/4					
BL00	Belt Loop Width	-0	0	1/2	1/2	1/2	1/2	1/2					
BL01	Belt Loop Length	-1/8	1/8	2 1/4	2 1/4	2 1/4	2 1/4	2 1/4					
HH01	Hem Height--Leg Opening	-1/8	1/8	5/8	5/8	5/8	5/8	5/8					
	FRONT POCKETS												
PP87	Pocket Placement- Horizontal from Side Seam	-1/8	1/8	3 3/4	3 3/4	3 3/4	3 3/4	3 3/4					
PP86	Pocket Placement- Vertical from Waist	-1/8	1/8	2 3/4	2 3/4	2 3/4	2 3/4	2 3/4					
PB85	Pocket Bag Length	-1/4	1/4	10	10	10	10	10					
PB86	Pocket Bag Width	-1/4	1/4	6	6	6	6	6					
	COIN POCKET												
CP51	Coin Pocket Width	-1/8	1/8	2 1/2	2 3/4	2 3/4	2 3/4	2 3/4					
CP54	Coin Pocket Placement- Waistband Seam	-1/8	1/8	1	1	1	1	1					
CP56	Coin Pocket Placement- Side Seam	-1/8	1/8	3/4	3/4	3/4	3/4	3/4					
	BACK POCKETS												



BF8BE9701BB

Label	Basic Editions	Ongoing 2011	Date Folder Modified	16 FEB 2011 11:59 AM
Size Range	B- 4-16	DENIM 5 PKT		
Boy	Ship Date	03 MAR 2008	SHGS Sourcing	Catherine Loong
Designer Galina Goldshteyn	Technical Design	Buyer	Sourcing	Howard Mohney
Pre-Production		Carryover	Reference/LY #	BBEF062004



Size Range: 8H-18H

POM	Description	Tol (-)	Tol (+)	8H	10H	[12H]	14H	16H					
PP88	Pocket Placement- Distance from Yoke at Side Seam	-1/8	1/8	1 1/2	1 1/2	1 1/2	1 1/2	1 1/2					
PP89	Pocket Plcmnt- Distance from Yoke near Center Back	-1/8	1/8	1	1	1	1	1					
PH90	Pocket Height at Center	-1/8	1/8	5 1/2	5 3/4	5 3/4	5 3/4	5 3/4					
PH91	Pocket Height at Side	-1/8	1/8	5	5 1/4	5 1/4	5 1/4	5 1/4					
PW92	Pocket Width at Top Edge--General	-1/8	1/8	5 1/2	5 3/4	5 3/4	5 3/4	5 3/4					
PW93	Pocket Width at Bottom	-1/8	1/8	4 1/2	4 3/4	4 3/4	4 3/4	4 3/4					

Final

**Fabric & Trim Details**

Sears Holdings Management Corporation

BF8BE9701BB

Label	Basic Editions	Ongoing 2011	Date Folder Modified	16 FEB 2011 11:59 AM	
Size Range	B- 4-16	DENIM 5 PKT			
Boy	Ship Date	03 MAR 2008	SHGS Sourcing	Catherine Loong	
Designer Galina Goldshteyn	Technical Design	Buyer	Sourcing	Howard Mohney	
Pre-Production		Carryover	Reference/LY #	BBEF062004	

			Color: Combination:	See Peg Sheet						Image
Item / Category	Item Information	Item Information Detail								
K1621BE-L	User comments:	W / Sz: 33mm x 23mm		N/A						
Woven Loop Label	Finish:	Wt:								
	Item Content:	V Name: Approved Suppliers								
	Constr:	Origin: Men/Wom/Boy/Girls								
Packaging & Labeling	Finish:									
Use: all										

K2957U-SC	User comments:	W / Sz: 23mm x 17mm		N/A						
Boys denim Relaxed Fit straight cut label	Finish:	Wt:								
	Item Content:	V Name: Avery Dennison								
	Constr:	Origin: Boys								
Packaging & Labeling	Finish:									
Use: all										

4039D-PWC	User comments:	W / Sz: 27 mm		N/A						
Printed care label w/content & COO	Finish:	Wt:								
	Item Content:	V Name: Approved Suppliers								
	Constr:	Origin: All								
Packaging & Labeling	Finish:			1						
Use: all										

Item Master Comments: Used for denim/casual bottoms/novelty tees/ boyswear/swimwear & children's apparel

K2899BE-MB-I	User comments:	W / Sz: 2.125" x 5.5"		N/A						
Boys denim Relaxed fit integrated matchbook w/call	Finish:	Wt:								
	Item Content:	V Name: Avery Dennison								
	Constr:	Origin: Boys								
Packaging & Labeling	Finish:									
Use: sizes 8-16										

Final

**Fabric & Trim Details**

Sears Holdings Management Corporation

BF8BE9701BB

Label	Basic Editions	Ongoing 2011	Date Folder Modified	16 FEB 2011 11:59 AM	
Size Range	B- 4-16	DENIM 5 PKT			
Boy	Ship Date	03 MAR 2008	SHGS Sourcing	Catherine Loong	
Designer Galina Goldshteyn	Technical Design	Buyer	Sourcing	Howard Mohney	
Pre-Production		Carryover	Reference/LY #	BBEF062004	

			<b>Color: Combination:</b>	See Peg Sheet						Image
--	--	--	--------------------------------	---------------	--	--	--	--	--	-------

Item / Category	Item Information	Item Information Detail								
K3065BE-MB-I	User comments:	W / Sz: 2.125" x 5.5"	N/A							
Relaxed fit int. MB w/o waist callout & sizes 4-7	Finish:	Wt:								
	Item Content:	V Name: Avery, Nexgen, SSI								
	Constr:	Origin: Boys								
Packaging & Labeling	Finish:									
Use: sizes 4-7										

K2897BE-SS	User comments:	W / Sz: 1.125" x 5.75	N/A							
Boys denim Relaxed Fit size strip	Finish:	Wt:								
	Item Content:	V Name: Avery Dennison								
	Constr:	Origin: Boys								
Packaging & Labeling	Finish:									
Use: all										

DH0628	User comments:	W / Sz:	N/A							
rope dye denim	Finish:	Wt:								
	Item Content: 100% ctn	V Name:								
	Constr: 72x46/ 7x6	Origin:								
Fabric	Finish:									
Use: body										
Item Master Comments: Tak Sang #tsc-214A rope dye 100% cotton 72x46/ 7x6										

C03 090F	User comments:	W / Sz:	White / 3oz/yd2							
70% polyester 30% cotton plian weave pocketing(CV)	Finish:	Wt:								
	Item Content:	V Name: Mainzer Minton								
	Constr:	Origin:								
Support Materials	Finish:									
Use: Natural for Light colors/Black for dark										

Final

## Fabric &amp; Trim Details

Sears Holdings Management Corporation

BF8BE9701BB

Label	Basic Editions	Ongoing 2011	Date Folder Modified	16 FEB 2011 11:59 AM
Size Range	B- 4-16	DENIM 5 PKT		
Boy	Ship Date	03 MAR 2008	SHGS Sourcing	Catherine Loong
Designer Galina Goldshteyn	Technical Design	Buyer	Sourcing	Howard Mohney
Pre-Production		Carryover	Reference/LY #	BBEF062004



			Color: Combination:	See Peg Sheet						Image
Item / Category	Item Information	Item Information Detail								
C02 103SM	User comments:	W / Sz:		1 1/2"						
Polyester/rubber knit (covered) elastic	Finish: Elongation 160%	Wt:								
	Item Content: Covered	V Name: Fastener Corp of America								
	Constr: 54 picks per inch	Origin:								
Support Materials	Finish: Soft finish									
Use: Sz 4-7, Non-roll, Soft										

C02 102SM	User comments:	W / Sz:		3/4"						
Polyester/rubber knit (covered) elastic	Finish: Elongation 140%	Wt:								
	Item Content: Covered	V Name:								
	Constr: 52 picks per inch	Origin:								
Support Materials	Finish:									
Use: Sz 8-16, buttonholes, med wt										

4 HOLE NON-METAL	User comments:	W / Sz:		24L / Clear						
4-Hole Non Metal	Finish:	Wt:								
	Item Content:	V Name:								
	Constr:	Origin:								
Closure	Finish:			2						
Use: Sz 8-16, Inside wb adjust										

Metal-closed end	User comments:	W / Sz:		MGTH-Antique Silver / 5						
Conventional metal teeth zippers closed end	Finish: Must be Nickel Free	Wt:								
	Item Content: Metal Teeth	V Name:								
	Constr: 0	Origin:								
Closure	Finish:			1						
Use:										

Final

## Fabric &amp; Trim Details

Sears Holdings Management Corporation

BF8BE9701BB

Label	Basic Editions	Ongoing 2011	Date Folder Modified	16 FEB 2011 11:59 AM	
Size Range	B- 4-16	DENIM 5 PKT			
Boy	Ship Date	03 MAR 2008	SHGS Sourcing	Catherine Loong	
Designer Galina Goldshteyn	Technical Design	Buyer	Sourcing	Howard Mohney	
Pre-Production		Carryover	Reference/LY #	BBEF062004	

			Color: Combination:	See Peg Sheet						Image
Item / Category	Item Information	Item Information Detail								
1601BE-R	User comments:	W / Sz:	14L / Antique							
Basic Edition Logo Rivet	Finish:	Wt:	Silver							
	Item Content:	V Name: Lamcom								
	Constr:	Origin:								
Packaging & Labeling	Finish:			4						
Use: front pockets										

1613BE-S	User comments:	W / Sz:	24L / Antique							
Basic Editions logo snap	Finish:	Wt:	Silver							
	Item Content:	V Name:								
	Constr:	Origin:								
Packaging & Labeling	Finish:			1						
Use: for size 4-7										

1600BE-LSB	User comments:	W / Sz:	27L / Antique							
Basic Edition Logo Shank button	Finish:	Wt:	Silver							
	Item Content:	V Name: Lamcom								
	Constr:	Origin:								
Packaging & Labeling	Finish:			1						
Use: for size 8-16										

th-td-01	User comments:	W / Sz:	See Peg							
cotton wrapped poly core thread	Finish:	Wt:	Sheet /							
	Item Content:	V Name:	TX120							
	Constr:	Origin:								
Support Materials	Finish:									
Use: All Topstitching										

BF8BE9701BB

Label	Basic Editions	Ongoing 2011	Date Folder Modified	16 FEB 2011 11:59 AM
Size Range	B- 4-16	DENIM 5 PKT		
Boy	Ship Date	03 MAR 2008	SHGS Sourcing	Catherine Loong
Designer Galina Goldshteyn	Technical Design	Buyer	Sourcing	Howard Mohney
Pre-Production		Carryover	Reference/LY #	BBEF062004



			Color: Combination:	See Peg Sheet						Image
Item / Category	Item Information	Item Information Detail		See Peg Sheet / T-40						
th-td-01	User comments:	W / Sz:								
cotton wrapped poly core thread	Finish:	Wt:								
	Item Content:	V Name:								
	Constr:	Origin:								
Support Materials	Finish:									
Use: All internal seams and bartacks										



--	--	--	--	--	--	--	--	--	--	--